

# ROLLER + SOLAR SHADES INSTALLATION INSTRUCTIONS

SIMPLY FOLLOW OUR STEP-BY-STEP INSTRUCTIONS AND YOUR BEAUTIFUL NEW SHADES WILL SOON BE ENHANCING YOUR HOME OR WORKSPACE FOR MANY YEARS TO COME.

## Getting Started:

Carefully unpack your shades and check to make sure you have the following installation parts. We recommend reading through these instructions before starting the installation.

## Parts Included:

- Screws
- Two mounting brackets
- Tension Device

Please note that your brackets must be securely attached to the mounting surface. If your screws do not hit wood studs you'll have to use a different fastener which can be found at any local hardware store.

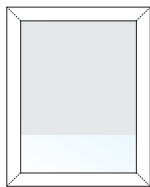

INSIDE MOUNT

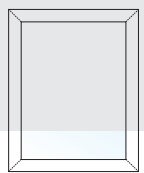

OUTSIDE MOUNT

## Tools You Will Need:

- Drill with a 1/8" bit & a Phillips bit
- Phillips screwdriver
- Metal tape measure

\* According to the Window Covering Manufacturers Association Inc., all labels must not be removed from the product.

\* To comply with child safety standards, all tension devices must be installed per the installation instructions provided in step 3

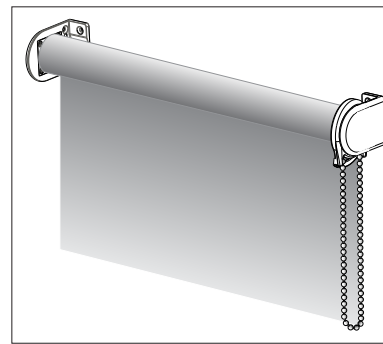
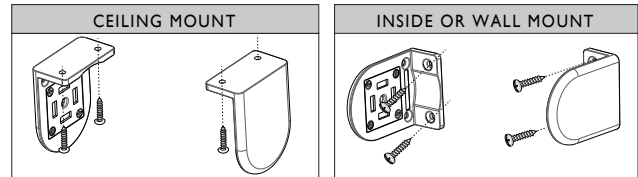

SHOWN AS REGULAR ROLL

## 1A. Installing Your Brackets:

**Inside Mount:** Attach the brackets to the window frame, window molding, wall or ceiling, as shown. Brackets are universal so clutch may be mounted on either side. There are 5 easy ways to install brackets. Choose which is best suited for your situation.

Proceed to step 2

### INSTALL BRACKETS UPWARD

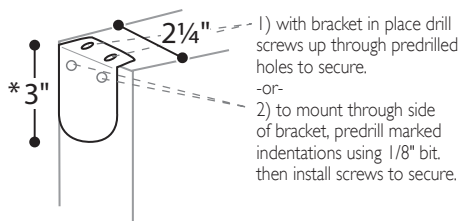

- 1) with bracket in place drill screws up through predrilled holes to secure.
- or-
- 2) to mount through side of bracket, predrill marked indentations using 1/8" bit, then install screws to secure.

### INSTALL BRACKETS STRAIGHT ON

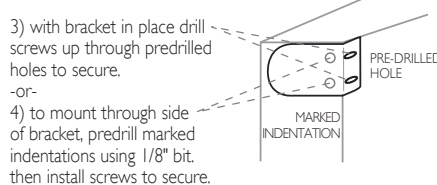

- 3) with bracket in place drill screws up through predrilled holes to secure.
- or-
- 4) to mount through side of bracket, predrill marked indentations using 1/8" bit, then install screws to secure.

### SHALLOW DEPTH BRACKET INSTALLATION

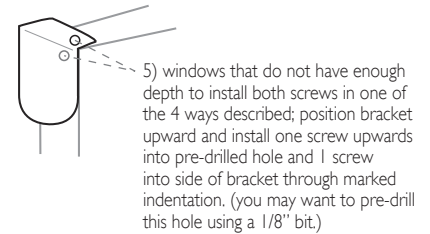

- 5) windows that do not have enough depth to install both screws in one of the 4 ways described; position bracket upward and install one screw upwards into pre-drilled hole and 1 screw into side of bracket through marked indentation, (you may want to pre-drill this hole using a 1/8" bit.)

\* Please note for thicker fabrics or longer lengths, we may provide an "extension" bracket to accommodate a larger roll diameter. In this case, the measurement from the "foot" to the curved area of the bracket would be 3 3/4".

# ROLLER + SOLAR SHADES INSTALLATION INSTRUCTIONS (continued)

SIMPLY FOLLOW OUR STEP-BY-STEP INSTRUCTIONS AND YOUR BEAUTIFUL NEW SHADES WILL SOON BE ENHANCING YOUR HOME OR WORKSPACE FOR MANY YEARS TO COME.

## 1B. Installing Your Brackets:

**Outside Mount:** Fit the shade into the brackets and center the shade over the window (this may take two people). With a pencil mark the wall on the side of one bracket. Remove shade and then attach the one bracket with two screws. Next, insert the shade into the second bracket. Hold shade up and insert other end into the already mounted bracket making sure that the shade is level. Mark the wall on the side of the second bracket. Remove shade, install second bracket with two screws.

Proceed to step 2

\* Please note for thicker fabrics or longer lengths, we may provide an "extension" bracket to accommodate a larger roll diameter. In this case, the measurement from the "foot" to the curved area of the bracket would be 3¾".

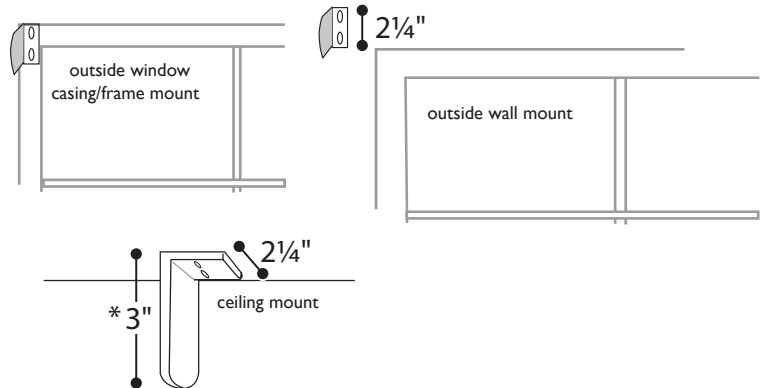

## 2. Inserting the Shade:

With the brackets now installed, you may install your shade.

**Step A:** Put the spring loaded pin end into the round hole of the bracket. Pushing the pin end towards its bracket, insert the hooks on the clutch side straight into the two slots in the bracket.

**Step B:** Once the two hooks are through the slots, gently pull down on the clutch until the two hooks have locked securely to the bracket. The bottom of the clutch should point straight down.

\* Please note: Roller shades are not meant to be lowered past the ordered length. The shade will come with additional material that is automatically added in length to conceal the roller tube and to help secure the fabric on the roll. We have attached metal ball stops on the chain to prevent the shade from being raised or lowered past its limits.

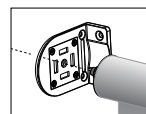

STEP A

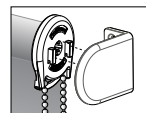

STEP B

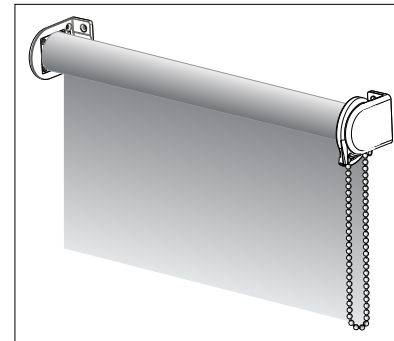

SHOWN AS REGULAR ROLL

## 3. Installing Tension Device (Continuous Loop Control):

### Consider Position of Tension Device:

The tension device should be positioned on the window frame or the wall so that the tension device and bead chain does not interfere with operation of window treatment.

The tension device should be installed so that bead chain is taut without stretching or pulling down on it. Stretching the bead chain will cause excessive wear. Do not twist or cross the bead chain.

### Install Tension Device:

Press and hold the back spring on the tension device that is pre-installed at the top of the continuous loop. With the spring held, slide the device down to the bottom of the loop to where you would like the device positioned.

Insert and secure the two screws through the holes in the device. The loop should now pass freely through the tension device.

**Please Note:** When attaching to wood, included screws can be screwed directly into wood. When attaching to drywall and metal, use anchors that are designed for such substrates. Visit your local hardware store for guidance on appropriate anchors for your substrate.

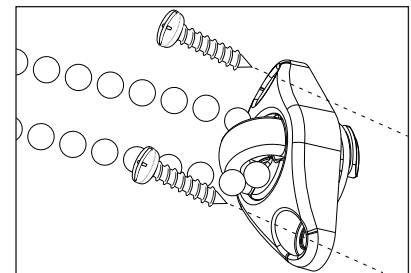

## Care and Cleaning:

Minimal care and cleaning is needed to maintain the beauty of your shades. **To vacuum:** Use a hand held, low suction vacuum. **To dust:** Use a soft, clean cloth or a feather duster.

## Warranty:

The Shade Store products are covered by a limited lifetime warranty. This warranty covers any defects in materials or workmanship so long as the product is measured and installed according to instructions. Every Shade Store window treatment is designed to provide trouble-free use. In the unlikely event that warranty service is ever needed, simply contact the Help Desk at [help@theshadestore.com](mailto:help@theshadestore.com) or 800-754-1455 for assistance.

# ROLLER + SOLAR SHADES WITH METAL VALANCE INSTALLATION INSTRUCTIONS

SIMPLY FOLLOW OUR STEP-BY-STEP INSTRUCTIONS AND YOUR BEAUTIFUL NEW SHADES WILL SOON BE ENHANCING YOUR HOME OR WORKSPACE FOR MANY YEARS TO COME.

## Getting Started:

Carefully unpack your shades and check to make sure you have the following installation parts. We recommend reading through these instructions before starting the installation.

## Parts Included:

- Screws
- Mounting brackets
- Tension Device

## Tools You Will Need:

- Drill with a 1/8" bit & a Phillips bit
- Phillips screwdriver
- Metal tape measure

\* According to the Window Covering Manufacturers Association Inc., all labels must not be removed from the product.

\* To comply with child safety standards, all tension devices must be installed per the installation instructions provided in step 3.

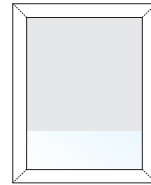

INSIDE MOUNT

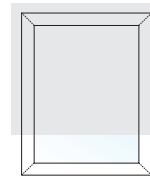

OUTSIDE MOUNT

## I. Select Mount Type:

Mount the brackets to the wall or window frame, with the outside brackets no further than 2 inches (5 cm) from the ends of the headrail. On wide shades, space the additional bracket(s) at equal intervals.



### Inside Mount:

For inside or ceiling mounts, use the top bracket holes.

Make sure the release tab is always mounted on the bottom.

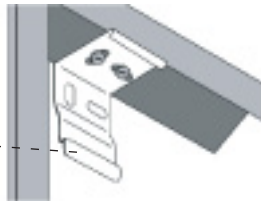

### Outside Mount:

For wall or outside mounts, use the rear bracket holes.

Make sure the release tab is always mounted on the bottom.

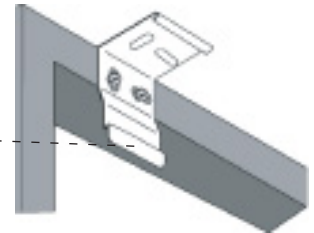

Please note that your brackets must be securely attached to the mounting surface. If your screws do not hit wood studs you'll have to use a different fastener which can be found at any local hardware store.

## 2. Mount the Headrail:

Position the headrail with the front panel (A) resting on the top lip of all brackets. push the bottom front of the headrail firmly backwards and toward the window until the lip on the rear of the headrail engages the bracket and snaps into place, (B) as shown.

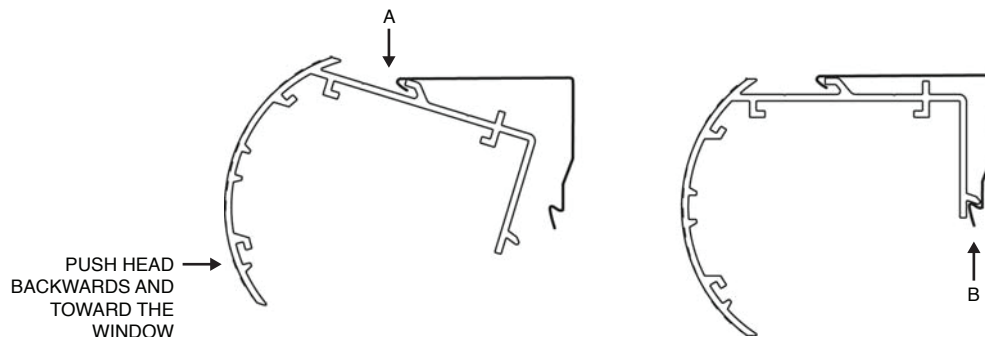

Please note: Roller shades are not meant to be lowered past the ordered length. The shade will come with additional material that is automatically added in length to conceal the roller tube and to help secure the fabric on the roll. We have attached metal ball stops on the chain to prevent the shade from being raised or lowered past its limits.

# ROLLER + SOLAR SHADES WITH METAL VALANCE INSTALLATION INSTRUCTIONS

SIMPLY FOLLOW OUR STEP-BY-STEP INSTRUCTIONS AND YOUR BEAUTIFUL NEW SHADES WILL SOON BE ENHANCING YOUR HOME OR WORKSPACE FOR MANY YEARS TO COME (CONTINUED)

## 3. Installing Tension Device (Continuous Loop Control):

### Consider Position of Tension Device:

The tension device should be positioned on the window frame or the wall so that the tension device and bead chain does not interfere with operation of window treatment.

The tension device should be installed so that bead chain is taut without stretching or pulling down on it. Stretching the bead chain will cause excessive wear. Do not twist or cross the bead chain.

### Install Tension Device:

Press and hold the back spring on the tension device that is pre-installed at the top of the continuous loop. With the spring held, slide the device down to the bottom of the loop to where you would like the device positioned.

Insert and secure the two screws through the holes in the device. The loop should now pass freely through the tension device.

**Please Note:** When attaching to wood, included screws can be screwed directly into wood. When attaching to drywall and metal, use anchors that are designed for such substrates. Visit your local hardware store for guidance on appropriate anchors for your substrate.

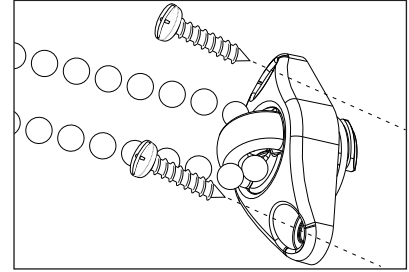

## Care and Cleaning:

Minimal care and cleaning is needed to maintain the beauty of your shades. **To vacuum:** Use a hand held, low suction vacuum. **To dust:** Use a soft, clean cloth or a feather duster.

## Warranty:

The Shade Store products are covered by a limited lifetime warranty. This warranty covers any defects in materials or workmanship so long as the product is measured and installed according to instructions. Every Shade Store window treatment is designed to provide trouble-free use. In the unlikely event that warranty service is ever needed, simply contact the Help Desk at [help@theshadestore.com](mailto:help@theshadestore.com) or 800-754-1455 for assistance.

# ROLLER+SOLAR SHADES WITH UPHOLSTERED VALANCE INSTALL INSTRUCTIONS

SIMPLY FOLLOW OUR STEP-BY-STEP INSTRUCTIONS AND YOUR BEAUTIFUL NEW SHADES WILL SOON BE ENHANCING YOUR HOME OR WORKSPACE FOR MANY YEARS TO COME.

## Getting Started:

Carefully unpack your shades and check to make sure you have the following installation parts. We recommend reading through these instructions before starting the installation.

## Parts Included:

- Screws
- “L” brackets (outside mount)
- Tension Device

Please note that your brackets must be securely attached to the mounting surface. If your screws do not hit wood studs you'll have to use a different fastener which can be found at any local hardware store.

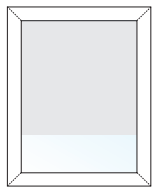

INSIDE MOUNT

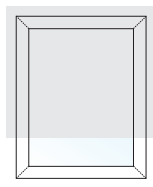

OUTSIDE MOUNT

## Tools You Will Need:

- Drill with a 1/8" bit & a Phillips bit
- Phillips screwdriver
- Metal tape measure

\* According to the Window Covering Manufacturers Association Inc., all labels must not be removed from the product.

\* To comply with child safety standards, all tension devices must be installed per the installation instructions provided in step 3.

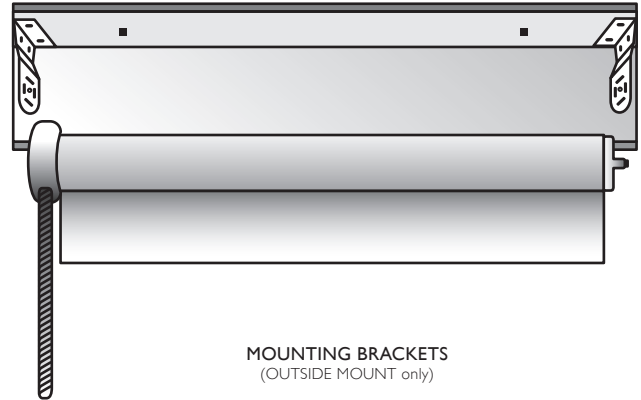

MOUNTING BRACKETS  
(OUTSIDE MOUNT only)

## IA. Mounting Your Roller/Solar Shades with Upholstered Valance:

### Inside Mount:

**Installing the valance:** The mounting holes are pre-drilled through the headrail / top of upholstered valance. (No “L” brackets needed for inside mount)

**Please note:** The pre-drilled holes may not be ideal for all install scenarios – if needed, you may pre-drill new holes as desired.

The shade and brackets come pre-mounted into the upholstered valance. Before installing the valance, remove the shade from the brackets. To remove, lift the chain side up of the shade slightly and push the roller in the direction of the opposite bracket.

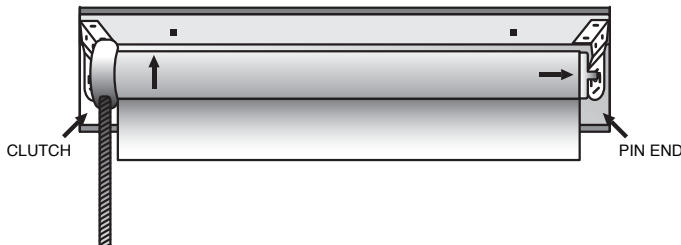

Start the screws in to the mounting holes and tighten until the tips of the screws are slightly showing on the top of the headrail. Hold the valance inside the window frame. With the valance properly positioned, push up on the headrail (top) of the valance allowing the screw tips to leave a small indentation on the window frame. Now drill a hole with an 1/8" drill bit at the indentations. Finish the job by drilling the screws in the headrail into the pre-drilled holes to secure the valance in place.

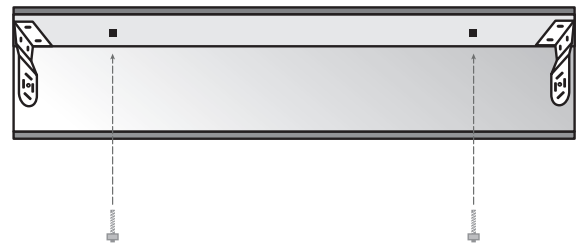

## IB. Mounting Your Roller /Solar Shades with Upholstered Valance:

### Outside Mount:

**Install the brackets:** The valance will be hung / attached to the window frame or wall with the “L” brackets included. Attach the brackets to the wall or window frame at the desired height. Attach the brackets using the long screws provided, making sure the brackets are level with each other.

The shade and brackets come pre-mounted into the upholstered valance. Before installing the valance, remove the shade from the brackets. To remove, lift the chain side up of the shade slightly and push the roller in the direction of the opposite bracket.

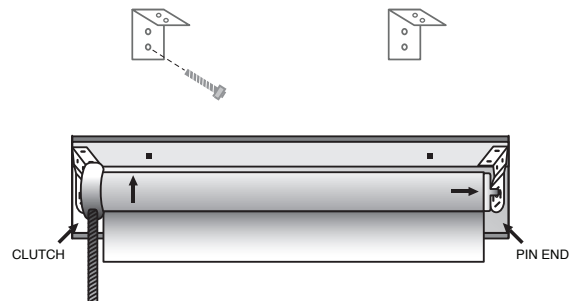

# ROLLER+SOLAR SHADES WITH UPHOLSTERED VALANCE INSTALL INSTRUCTIONS

SIMPLY FOLLOW OUR STEP-BY-STEP INSTRUCTIONS AND YOUR BEAUTIFUL NEW SHADES WILL SOON BE ENHANCING YOUR HOME OR WORKSPACE FOR MANY YEARS TO COME. (CONTINUED)

## 1.C. Mounting Your Roller /Solar Shades with Upholstered Valance:

**Install the valance:** Set the headrail /top of valance on the brackets. Center the valance against the wall or window frame. Mark hole and pre-drill using a 1/8" drill bit at each bracket location. Attach the upholstered valance to the brackets using the short screws provided.

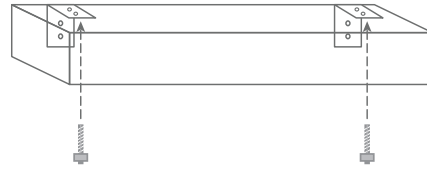

## 2. Inserting the Shade:

With the valance now installed, you may install your shade into the pre-mounted brackets on the sides of the valance:

**Step A:** Put the spring loaded pin end into the round hole of the bracket. Pushing the pin end towards its bracket, insert the hooks on the clutch side straight into the two slots in the bracket.

**Step B:** Once the two hooks are through the slots, gently pull down on the clutch until the two hooks have locked securely to the bracket. The bottom of the clutch should point straight down.

Please note: Roller shades are not meant to be lowered past the ordered length. The shade will come with additional material that is automatically added in length to conceal the roller tube and to help secure the fabric on the roll. We have attached metal ball stops on the chain to prevent the shade from being raised or lowered past its limits.

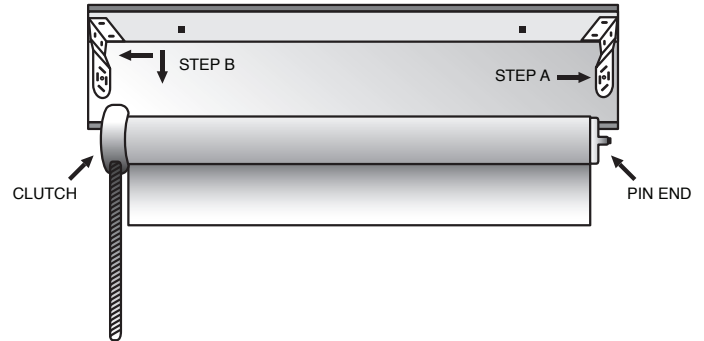

## 3. Installing Tension Device (Continuous Loop Control):

### Consider Position of Tension Device:

The tension device should be positioned on the window frame or the wall so that the tension device and bead chain does not interfere with operation of window treatment.

**The tension device should be installed so that bead chain is taut without stretching or pulling down on it. Stretching the bead chain will cause excessive wear. Do not twist or cross the bead chain.**

### Install Tension Device:

Press and hold the back spring on the tension device that is pre-installed at the top of the continuous loop. With the spring held, slide the device down to the bottom of the loop to where you would like the device positioned.

Insert and secure the two screws through the holes in the device. The loop should now pass freely through the tension device.

**Please Note:** When attaching to wood, included screws can be screwed directly into wood. When attaching to drywall and metal, use anchors that are designed for such substrates. Visit your local hardware store for guidance on appropriate anchors for your substrate.

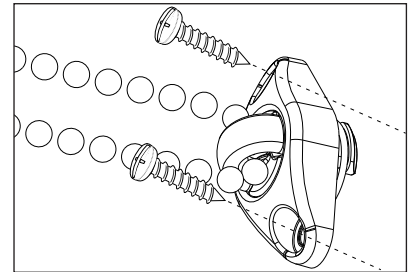

## Care and Cleaning:

Minimal care and cleaning is needed to maintain the beauty of your shades. **To vacuum:** Use a hand held, low suction vacuum. **To dust:** Use a soft, clean cloth or a feather duster.

## Warranty:

The Shade Store products are covered by a limited lifetime warranty. This warranty covers any defects in materials or workmanship so long as the product is measured and installed according to instructions. Every Shade Store window treatment is designed to provide trouble-free use. In the unlikely event that warranty service is ever needed, simply contact the Help Desk at [help@theshadestore.com](mailto:help@theshadestore.com) or 800-754-1455 for assistance.

# CORDLESS ROLLER SHADE WITH DECORATIVE RAIL INSTALLATION INSTRUCTIONS

SIMPLY FOLLOW OUR STEP-BY-STEP INSTRUCTIONS AND YOUR BEAUTIFUL NEW SHADES WILL SOON BE ENHANCING YOUR HOME OR WORKSPACE FOR MANY YEARS TO COME.

## Getting Started:

Carefully unpack your shades and check to make sure you have the following installation parts. We recommend reading through these instructions before starting the installation.

## Parts Included:

- Screws
- Mounting brackets

Please note that your brackets must be securely attached to the mounting surface. If your screws do not hit wood studs you'll have to use a different fastener which can be found at any local hardware store.

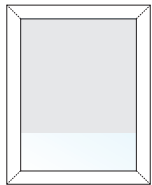

INSIDE MOUNT

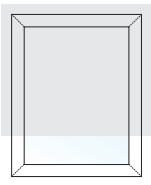

OUTSIDE MOUNT

## Tools You Will Need:

- Drill with a 1/8" bit & a Phillips bit
- Phillips screwdriver
- Metal tape measure
- Pencil

\* According to the Window Covering Manufacturers Association Inc., all labels must not be removed from the product.

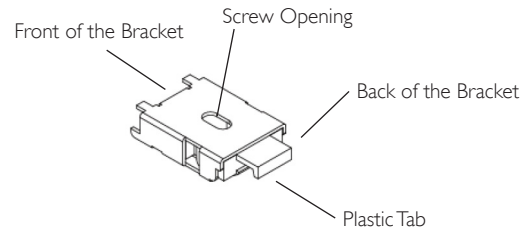

Make sure that you are mounting to a level surface. If your shade does not sit level, the fabric will not roll up evenly which could damage the edges of the fabric.

## I. Installing Your Brackets:

### Installing Inside Mount:

The brackets will be attached to the top of the window frame (or ceiling) as shown.

The outermost brackets should be installed approximately 2" from the edge of the window frame. Any remaining brackets will be spaced out evenly in between the outermost brackets.

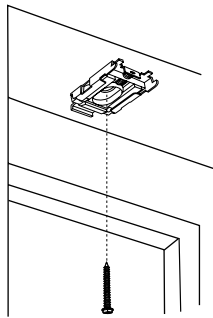

Before drilling the screw in and securely tightening the bracket to the mounting surface, make sure that the plastic tab on the bracket is facing towards the back of the window.

### Installing Outside Mount:

The brackets will be attached above the window frame as shown.

The outermost brackets should be installed approximately 2" from the edge of the window frame. Any remaining brackets will be spaced out evenly in between the outermost brackets.

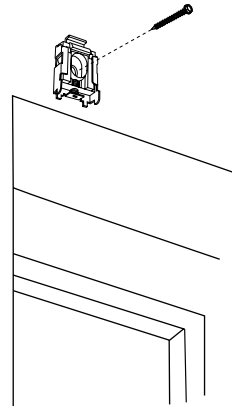

Before drilling the screw in and securely tightening the bracket to the mounting surface, make sure that the plastic tab on the bracket is facing upward/ towards the ceiling.

## 2A. Inserting The Shade Into The Brackets:

### Installing Inside Mount:

- Insert the rail into the front of the bracket.
- Rotate the shade until the back side of it snaps into the back of the bracket.

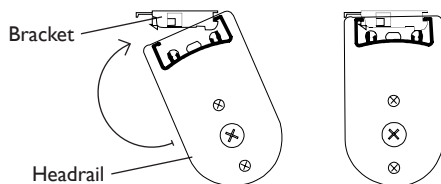

### Installing Outside Mount:

- Insert the rail into the bottom of the bracket.
- Rotate the shade until the back side of it snaps into the back of the bracket.

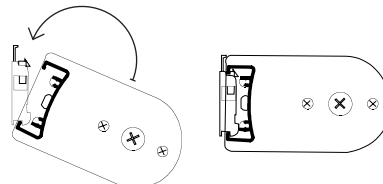

**CORDLESS ROLLER SHADE WITH DECORATIVE RAIL INSTALLATION INSTRUCTIONS CONTINUED**  
 SIMPLY FOLLOW OUR STEP-BY-STEP INSTRUCTIONS AND YOUR BEAUTIFUL NEW SHADES WILL SOON BE ENHANCING YOUR HOME OR WORKSPACE FOR MANY YEARS TO COME.

**2B. Removing The Shade From The Brackets:**

**BEFORE ATTEMPTING, PLEASE MAKE SURE THAT YOU HAVE A SECURE HOLD ON THE SHADE TO PREVENT IT FROM FALLING.**

**Installing Inside Mount:**

- Using either your finger or a flat head screwdriver, press the tab of the bracket in.
- Once the tab has been pressed in, rotate the shade in toward the room until it is fully removed off of the bracket.

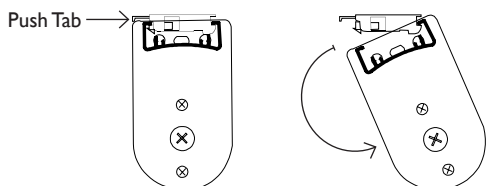

**Installing Outside Mount:**

- Using either your finger or a flat head screwdriver, press the tab of the bracket down.
- Once the tab has been pressed in, rotate the shade down until it is fully removed off of the bracket.

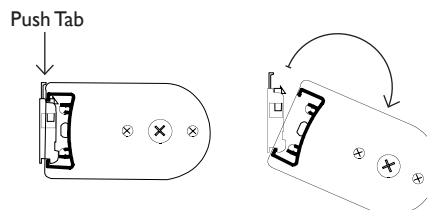

**3. Adjusting The Tension On Your Shade:**

With the brackets now installed, you may install your shade.

If your shade has too much tension (springs up too quickly) or too little (does not reach the top), the level of tension can be adjusted.

Begin by locating the acrylic tension or adjustment screws on your shade's headrail.

If your shade is in a metal valance, you must remove the end cap on the valance first.

If your shade is in an upholstered valance, you may need to remove the shade from the valance first. Please refer to step 2B.

**Regular Roll**

Adjustments can be made on the screw to the LEFT hand side of your shade.

- Using a Phillips head or Flat Head screwdriver, turn the screw until the desired tension is reached.
- Turning clockwise will INCREASE the tension
- Turning counter clockwise will DECREASE the tension

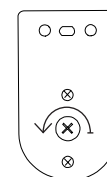

**Reverse Roll**

Adjustments can be made on the screw to the RIGHT hand side of your shade.

- Using a screwdriver, turn the screw until the desired tension is reached.
- Turning clockwise will INCREASE the tension
- Turning counter clockwise will DECREASE the tension

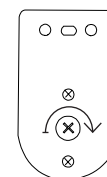

**4. Adjusting The Upper Limit On Your Shade:**

Upon retracting your shade, if it does not stop at a satisfactory upper limit, the upper limit can be adjusted.

Begin by locating the acrylic tension or adjustment screws on your shade's headrail.

If your shade is in a metal valance, you must remove the end cap on the valance first.

If your shade is in an upholstered valance, you may need to remove the shade from the valance first. Please refer to step 2B.

**Regular Roll**

Adjustments can be made on the screw to the RIGHT hand side of your shade.

- Using a Phillips head or Flat Head screwdriver, turn the screw until the desired tension is reached.
- Turning clockwise will LOWER the upper limit.
- Turning counter clockwise will RAISE the upper limit.

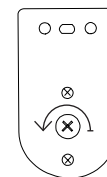

**Reverse Roll**

Adjustments can be made on the screw to the LEFT hand side of your shade.

- Using a Phillips head or Flat Head screwdriver, turn the screw until the desired tension is reached.
- Turning clockwise will LOWER the upper limit.
- Turning counter clockwise will RAISE the upper limit.

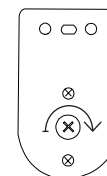

**Warranty:**

The Shade Store products are covered by a limited lifetime warranty. This warranty covers any defects in materials or workmanship so long as the product is measured and installed according to instructions. Every Shade Store window treatment is designed to provide trouble-free use. In the unlikely event that warranty service is ever needed, simply contact customer care at [help@theshadestore.com](mailto:help@theshadestore.com) or 800-754-1455 for assistance.